

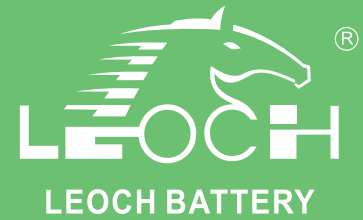

PLC-Pure Lead Long Cycle Life PLC 100 (12V90Ah)



Specifications

Rated Voltage	12V	
Nominal Capacity	C ₁₀ , 1.80V/cell	90Ah
	C ₂₀ , 1.80V/cell	96.6Ah
Dimension	Length	341.5±2mm (13.44 inches)
	Width	175±2mm (6.89 inches)
	Container Height	213±2mm (8.39 inches)
	Total Height	215±2mm (8.46 inches)
Approx. Weight	32.5 Kg (71.5 lbs)	
Terminal	M8	
Container Material	PC-ABS flame retardant jar and cover to UL94 V-0	
Rated Capacity (25°C)	96.6 Ah	(20hr, 4.83A, 1.80V/cell)
	90.0 Ah	(10hr, 9.00A, 1.80V/cell)
	77.5 Ah	(5hr, 15.5A, 1.75V/cell)
	72.6 Ah	(3hr, 24.2A, 1.75V/cell)
	64.0 Ah	(1hr, 64.0A, 1.60V/cell)
Max. Discharge Current	1200A	
Internal Resistance (25°C)	Approx. 4.0mΩ(Fully charged)	
Operating Temp. Range	Discharge	-40 ~ 65°C (-40 ~ 149°F)
	Charge	0 ~ 54°C (32 ~ 129°F)
	Storage	-20 ~ 40°C (-4 ~ 104°F)
Nominal Operating Temp. Range	25±3°C (77±5°F)	
Max. Charging Current(25°C)	27.0A	
Charge voltage(25°C)	Float	13.62V
	Temp. Coefficient	-3mV/cell/°C
	Equalization(Cycle)	14.1~14.4V
Effect of temp. to Capacity	40°C (104°F)	103%
	25°C (77°F)	100%
	0°C (32°F)	86%
Self Discharge	<p>PIC series batteries can be stored up to 24 months at 25°C(77°F), For higher temperatures the time interval will be shorter. Battery needs to be given a freshening charge when the OCV approach 2.10V/cell or when the maximum storage time is reached, whichever occurs first.</p>	



Layout

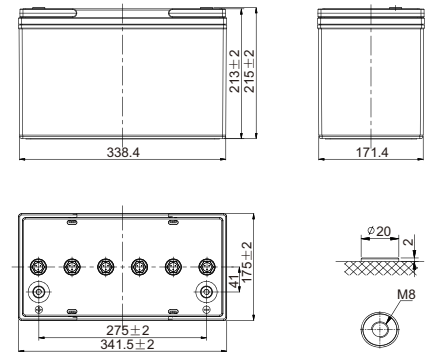

Unit: mm

Constant Current Discharge (Amperes) at 25 °C (77° F)

F.V/Time	10min	15min	20min	30min	45min	1h	2h	3h	4h	5h	8h	10h	20h
1.85V/cell	154.1	129.2	112.4	88.2	67.6	54.9	31.9	22.6	17.7	14.6	10.2	8.57	4.60
1.80V/cell	171.2	142.2	122.0	94.3	72.0	58.3	33.7	23.8	18.6	15.4	10.7	9.00	4.83
1.75V/cell	182.3	149.8	128.8	98.5	74.2	60.0	34.3	24.2	18.9	15.5	10.8	9.10	4.88
1.70V/cell	194.6	157.3	133.9	101.0	75.8	61.6	34.9	24.4	19.0	15.7	10.9	9.16	4.92
1.67V/cell	204.0	163.8	137.2	104.2	77.8	62.8	35.2	24.7	19.2	15.8	11.0	9.22	4.95
1.60V/cell	212.5	171.0	141.2	106.7	79.6	64.0	35.7	25.0	19.4	16.0	11.1	9.27	4.97

Constant Power Discharge (Watts/cell) at 25 °C (77° F)

F.V/Time	10min	15min	20min	30min	45min	1h	2h	3h	4h	5h	8h	10h	20h
1.85V/cell	292.9	247.2	216.2	171.7	133.6	108.9	63.8	45.4	35.6	29.5	20.7	17.4	9.39
1.80V/cell	320.6	268.4	232.5	182.4	141.5	115.0	67.0	47.5	37.3	30.9	21.7	18.2	9.82
1.75V/cell	337.7	280.0	243.3	188.9	144.7	117.7	67.9	48.1	37.6	31.1	21.8	18.4	9.90
1.70V/cell	356.3	291.5	250.5	192.1	147.1	120.0	68.6	48.4	37.8	31.3	22.0	18.5	9.93
1.67V/cell	367.6	299.6	254.6	197.4	150.2	121.9	69.2	48.7	38.0	31.5	22.1	18.5	10.0
1.60V/cell	374.8	307.1	257.7	199.7	151.9	123.1	69.5	48.9	38.1	31.7	22.1	18.5	10.0



PLC-Pure Lead Long Cycle Life

PLC 100 (12V90Ah)

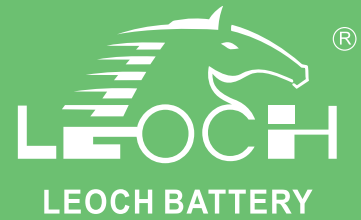

Applications

- Unstable Grid System
- UPS System
- Renewable Energy System

General Features

- 15 years design life(25°C)
- Outstanding high rate charge capability with Thin Plate Pure Lead technology
- High-rate performance, high energy density
- Virgin pure lead plates / copper alloy
- High quality AGM separators minimize electrical resistance to allow high current discharging properties.

Standards

- Compliance with IEC 60896 standards
- UL, CE Certified
- Manufactured in Leoch@IATF16949, OHSAS 18001, ISO 9001 and ISO 14001 certified production facilities

Discharge Characteristics

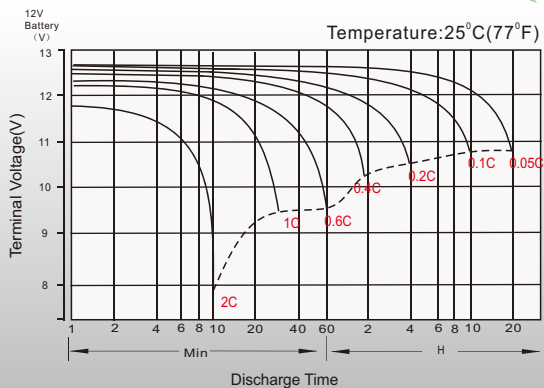

Float Charging Characteristics

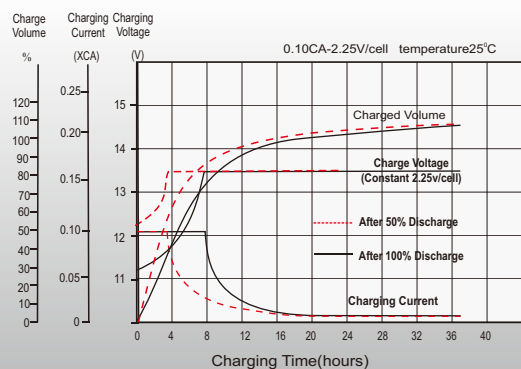

Cycle Life vs. Depth of Discharge

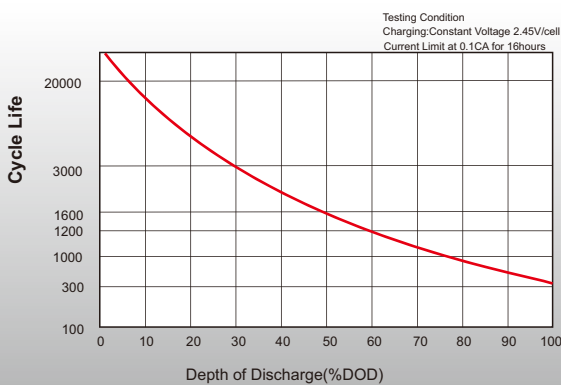

Self-discharge Characteristics

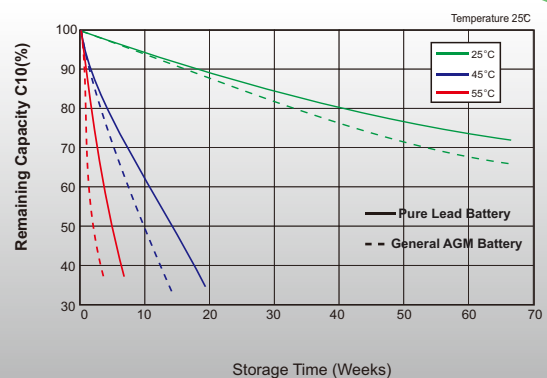

Sales Offices Worldwide

China Sales Office

5th Floor, Xinbaohui Bldg., Nanhai Blvd.,
Nanshan, Shenzhen, China. 518052
Tel: +86-755-86036060 (100 lines)
Fax: +86-755-26067269
E-mail: export@leoch.com

HongKong Sales Office

Workshop C, 33/F, TML Tower, No. 3 Hoi Shing Road,
Tsuen Wan, New Territories, Hong Kong
Tel: +852 35786666
Fax: +44 1452 690125
E-mail: sales.hk@leoch.com

Singapore Sales Office

No. 1 Tech Park Crescent,
Singapore 638131
Tel: +65 68636078
Fax: +65 6863 6079
Email: sales.sg@leoch.com

Australia Sales Office

2 /29 Tarlington Place, Smithfield. NSW 2164
Australia
Tel: 02 9756 0950
E-mail: sales.au@leoch.com

North America Sales Office

19751 Descartes
Foothill Ranch, CA 92610, USA
Tel: 949-588-5853
Fax: 949-588-5966
E-mail: sales@leoch.us
Http://www.leoch.us

UK Sales Office

9B Wheatstone Court. Waterwells, Business Park,
Gloucester, GL2-2AQ, UK United Kingdom
Tel: +44(0) 1452 729428 / 1452 729696
Fax: +44 1452 690125
E-mail: Sales.Europe@leoch.com
Http://www.leoch.eu

EMEA Sales Office

1 Deligiorgi St., 121 31 Athens,
Greece
Tel: +30 210 5760318 (2 lines)
E-mail: support_EMEA@leoch.com
Http://www.leoch.eu

India Sales Office

Shed no.A-53(b), 2nd Stage of Peenya Industrial Area,
Bangalore North Taluk, Bangalore-560058, India
Tel: +91-80-23440018/23440019
Fax: +91-80-23440017
E-mail: indiasales@leoch.com



[Http://www.leoch.com](http://www.leoch.com)

© 2021 LEOCH. All rights reserved.

Trademarks and logos are the property of LEOCH and its affiliates unless otherwise noted.
Subject to revisions without prior notice.

Publication No.: LB-PLC100-PD-EN-V2.1-202101