

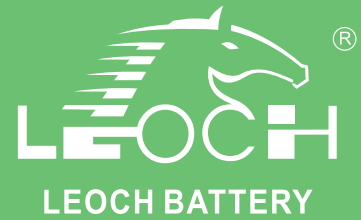

PLC-Pure Lead Long Cycle Life PLC 190FT (12V170Ah)



Specifications

Rated Voltage	12V	
Nominal Capacity	C ₁₀ 1.80V/cell	135Ah
	C ₂₀ 1.80V/cell	140Ah
Dimension	Length	562±2mm (22.1 inches)
	Width	125±2mm (4.92 inches)
	Container Height	320±2mm (12.6 inches)
	Total Height	320±2mm (12.6 inches)
Approx. Weight	58.7 Kg (129.4 lbs)	
Terminal	M8	
Container Material	PC-ABS flame retardant jar and cover to UL94 V-0	
Rated Capacity (25°C)	180.0 Ah	(20hr, 9.00A, 1.80V/cell)
	170.0 Ah	(10hr, 17.0A, 1.80V/cell)
	156.5 Ah	(5hr, 31.3A, 1.75V/cell)
	144.6 Ah	(3hr, 48.2A, 1.75V/cell)
	121.6 Ah	(1hr, 121.6A, 1.60V/cell)
Max. Discharge Current	1500A	
Internal Resistance (25°C)	Approx. 3.0mΩ(Fully charged)	
Operating Temp. Range	Discharge	-40 ~ 65°C (-40 ~ 149°F)
	Charge	0 ~ 54°C (32 ~ 129°F)
	Storage	-20 ~ 40°C (-4 ~ 104°F)
Nominal Operating Temp. Range	25±3°C (77±5°F)	
Max. Charging Current (25°C)	51.0A	
Charge voltage (25°C)	Float	13.62V
	Temp. Coefficient	-3mV/cell/°C
	Equalization (Cycle)	14.1~14.4V
Effect of temp. to Capacity	40°C (104°F)	103%
	25°C (77°F)	100%
	0°C (32°F)	86%
Self Discharge	PIC series batteries can be stored up to 24 months at 25°C(77°F), For higher temperatures the time interval will be shorter. Battery needs to be given a freshening charge when the OCV approach 2.10V/cell or when the maximum storage time is reached, whichever occurs first.	



Layout

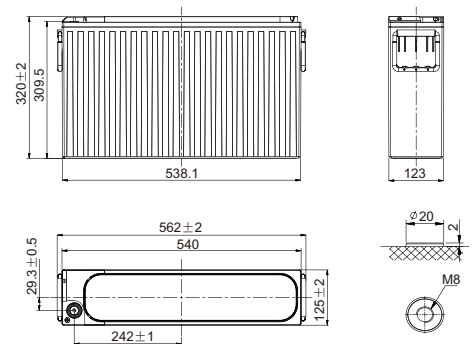

Unit: mm

Constant Current Discharge (Amperes) at 25 °C (77°F)

F.V/Time	10min	15min	20min	30min	45min	1h	2h	3h	4h	5h	8h	10h	20h
1.85V/cell	258.8	236.6	209.3	170.1	132.4	110.0	65.5	46.9	36.8	30.5	20.5	16.90	8.81
1.80V/cell	292.0	256.4	223.6	176.6	136.5	112.9	66.5	47.6	37.4	31.1	20.8	17.00	9.00
1.75V/cell	316.7	271.4	234.8	184.3	141.9	115.5	67.2	48.2	37.9	31.3	20.9	17.10	9.05
1.70V/cell	342.7	289.0	245.3	190.0	144.8	117.5	68.0	48.7	38.1	31.5	21.0	17.20	9.08
1.67V/cell	361.5	301.9	253.0	196.1	147.8	119.7	68.8	49.0	38.5	31.7	21.1	17.30	9.13
1.60V/cell	378.6	313.0	260.6	202.1	150.5	121.6	69.8	49.5	38.8	32.0	21.2	17.50	9.16

Constant Power Discharge (Watts/cell) at 25 °C (77°F)

F.V/Time	10min	15min	20min	30min	45min	1h	2h	3h	4h	5h	8h	10h	20h
1.85V/cell	495.6	457.0	407.9	334.1	261.6	218.1	130.8	93.9	74.1	61.6	41.6	35.6	18.0
1.80V/cell	552.8	489.2	431.8	344.3	267.9	222.6	132.1	95.1	75.0	62.4	42.0	35.7	18.3
1.75V/cell	590.3	512.7	449.2	356.2	276.2	226.3	133.1	95.9	75.5	62.7	42.1	35.8	18.3
1.70V/cell	631.6	539.8	464.0	363.9	280.1	229.1	133.9	96.3	75.9	63.0	42.2	35.9	18.3
1.67V/cell	655.7	556.4	473.3	372.9	284.2	232.3	135.1	96.7	76.2	63.2	42.3	36.0	18.4
1.60V/cell	676.4	570.1	482.0	380.6	287.4	233.8	135.6	97.0	76.4	63.5	42.6	36.2	18.4



PLC-Pure Lead Long Cycle Life

PLC 190FT (12V170Ah)

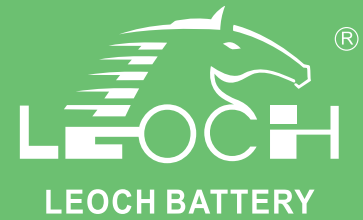

Applications

- Unstable Grid System
- UPS System
- Renewable Energy System

General Features

- 15 years design life(25°C)
- Outstanding high rate charge capability with Thin Plate Pure Lead technology
- High-rate performance, high energy density
- Virgin pure lead plates / copper alloy
- High quality AGM separators minimize electrical resistance to allow high current discharging properties.

Standards

- Compliance with IEC 60896 standards
- UL, CE Certified
- Manufactured in Leoch@IATF16949, OHSAS 18001, ISO 9001 and ISO 14001 certified production facilities

Discharge Characteristics

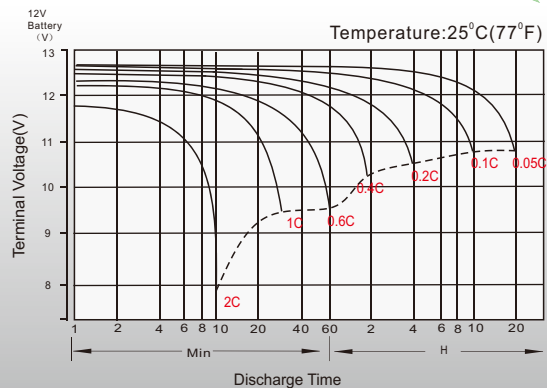

Float Charging Characteristics

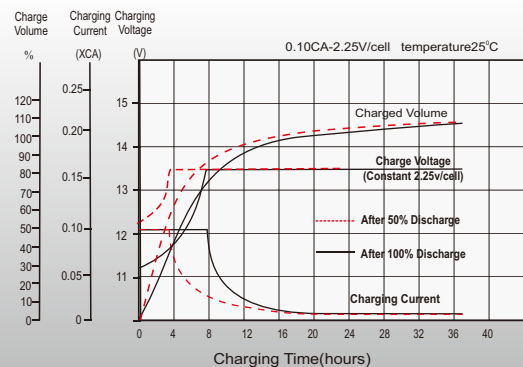

Cycle Life vs. Depth of Discharge

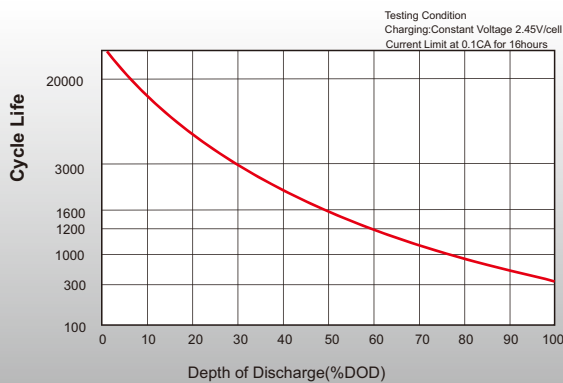

Self-discharge Characteristics

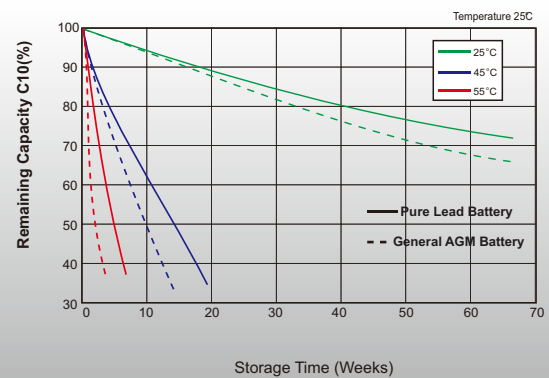

Sales Offices Worldwide

China Sales Office

5th Floor, Xinbaohui Bldg., Nanhai Blvd.,
Nanshan, Shenzhen, China. 518052
Tel: +86-755-86036060 (100 lines)
Fax: +86-755-26067269
E-mail: export@leoch.com

HongKong Sales Office

Workshop C, 33/F, TML Tower, No. 3 Hoi Shing Road,
Tsuen Wan, New Territories, Hong Kong
Tel: +852 35786666
Fax: +44 1452 690125
E-mail: sales.hk@leoch.com

Singapore Sales Office

No. 1 Tech Park Crescent,
Singapore 638131
Tel: +65 68636078
Fax: +65 6863 6079
Email: sales.sg@leoch.com

Australia Sales Office

2 /29 Tarlington Place, Smithfield. NSW 2164
Australia
Tel: 02 9756 0950
E-mail: sales.au@leoch.com

North America Sales Office

19751 Descartes
Foothill Ranch, CA 92610, USA
Tel: 949-588-5853
Fax: 949-588-5966
E-mail: sales@leoch.us
Http://www.leoch.us

UK Sales Office

9B Wheatstone Court. Waterwells, Business Park,
Gloucester, GL2-2AQ, UK United Kingdom
Tel: +44(0) 1452 729428 / 1452 729696
Fax: +44 1452 690125
E-mail: Sales.Europe@leoch.com
Http://www.leoch.eu

EMEA Sales Office

1 Deligiorgi St., 121 31 Athens,
Greece
Tel: +30 210 5760318 (2 lines)
E-mail: support_EMEA@leoch.com
Http://www.leoch.eu

India Sales Office

Shed no.A-53(b), 2nd Stage of Peenya Industrial Area,
Bangalore North Taluk, Bangalore-560058, India
Tel: +91-80-23440018/23440019
Fax: +91-80-23440017
E-mail: indiasales@leoch.com



[Http://www.leoch.com](http://www.leoch.com)

© 2021 LEOCH. All rights reserved.

Trademarks and logos are the property of LEOCH and its affiliates unless otherwise noted.
Subject to revisions without prior notice.

Publication No.: LB-PLC190FT-PD-EN-V2.1-202101