

EFB START-STOP BATTERY

EFB-L3 (12V70Ah)



CHARACTERISTICS

Item	Specifications	
Nominal Voltage	12V	
Nominal Capacity (20HR)	70Ah	
Reserve Capacity	120min	
Cold Cranking Amps@0°F (-18°C)	700A	
Dimension	Length	278mm(10.9inches)
	Width	175mm(6.89inches)
	Height	190mm(7.48inches)
Approx Weight	20kg(44.1lbs)	
Terminal	1	
Cell layout	0	
Hold-Down	B13	
Case	Black-PP Material	
Cover	Black-PP Material	
Handle	TS6	

APPLICATIONS

- Car with start-stop system
- EV/HEV
- Engine start

GENERAL FEATURES

- High capacity and high CCA
- 2x Faster Charge Acceptance than conventional starter batteries
- 2x Higher Cycle Life than conventional starter batteries
- Strong alloy grids for rugged durability and improved tolerance in extreme temperature conditions
- OE quality certification

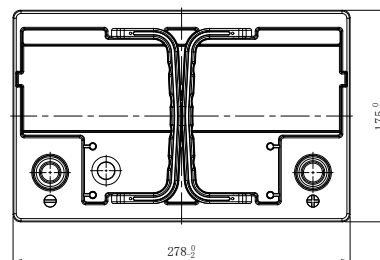
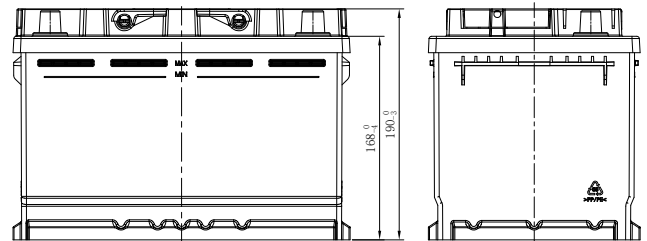
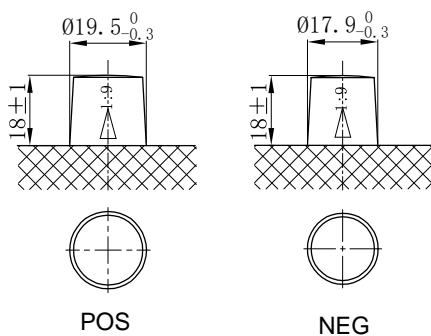

*Values are subject to variation of +/- 5% in normal manufacturing processes.

Leoch International Technology Ltd.
www.leoch.com

Leoch Batteries Pte Ltd
www.leoch.sg

Leoch Battery Corporation
www.leochamericas.com

Leoch Europe S.A.
www.leoch.eu

Data above is recommended and the picture is only for battery effect display, Leoch reserve the final right of explanation.
 © LEOCH. All rights reserved. Trademarks and logos are the property of LEOCH and its affiliates unless otherwise noted. Subject to revisions without prior notice. E&OE.

Publication No.:LB-EFB-L3-PD-EN-V1.0-20250220