

FLOODED BATTERY

54514 (12V45Ah)



CHARACTERISTICS

Item	Specifications	
Nominal Voltage	12V	
Nominal Capacity (20HR)	45Ah	
Reserve Capacity	70min	
Cold Cranking Amps@0°F (-18°C)	430A	
Dimension	Length	242mm(9.53inches)
	Width	175mm(6.89inches)
	Height	175mm(6.89inches)
Approx Weight	12.7kg(28.0lbs)	
Terminal	1	
Cell layout	1	
Hold-Down	B13	
Case	Black-PP Material	
Cover	Black-PP Material	
Handle	TS2	

APPLICATIONS

- Car start
- EV/HEV
- Engine start

GENERAL FEATURES

- High capacity and high CCA
- Long life
- Advanced lead-calcium alloy technology, maintenance-free design
- Patented venting system bring less water loss and prevent acid leakage
- OE quality certification

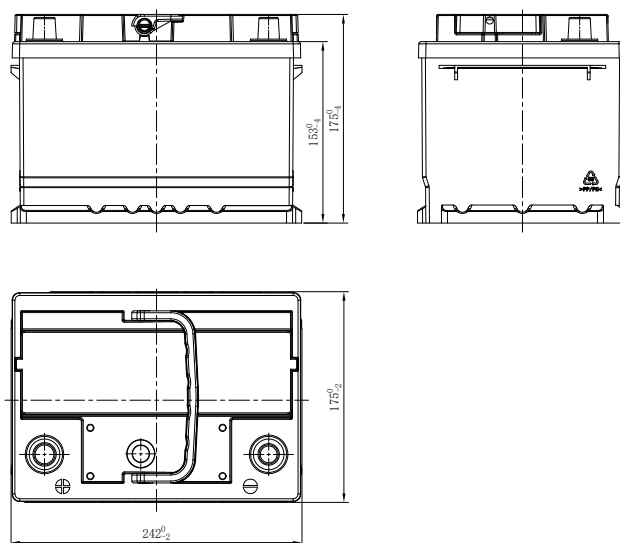
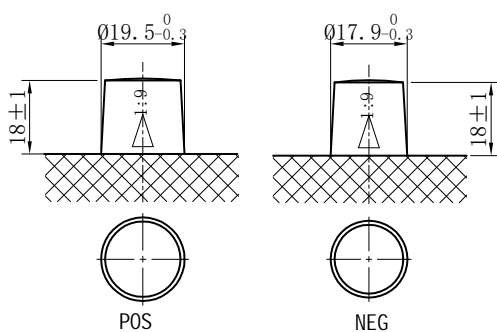

*Values are subject to variation of +/- 5% in normal manufacturing processes.

Leoch International Technology Ltd.
www.leoch.com

Leoch Batteries Pte Ltd
www.leoch.sg

Leoch Battery Corporation
www.leochamericas.com

Leoch Europe S.A.
www.leoch.eu

Data above is recommended and the picture is only for battery effect display, Leoch reserve the final right of explanation.
 © LEOCH. All rights reserved. Trademarks and logos are the property of LEOCH and its affiliates unless otherwise noted. Subject to revisions without prior notice. E&OE.

Publication No.:LB-54514-PD-EN-V1.0-20250220