

# FLOODED HIGH TEMPERATURE BATTERY

70D31RHT (12V70Ah)



## CHARACTERISTICS

Item	Specifications	
Nominal Voltage	12V	
Nominal Capacity (20HR)	70Ah	
Reserve Capacity	118min	
Cold Cranking Amps@0°F (-18°C)	470A	
Dimension	Length	303mm(11.9inches)
	Width	170mm(6.69inches)
	Height	222mm(8.74inches)
Approx Weight	19.3kg(42.5lbs)	
Terminal	1	
Cell layout	1	
Hold-Down	B1	
Case	Black-PP Material	
Cover	Black-PP Material	
Handle	TS1	

## APPLICATIONS

- Car start
- EV/HEV
- Engine start

## GENERAL FEATURES

- Design for high temperature countries and regions
- Superior life in high temperature environment
- High tin alloy and thicker positive grid
- High-temp paste
- Patented venting system bring less water loss and prevent acid leakage

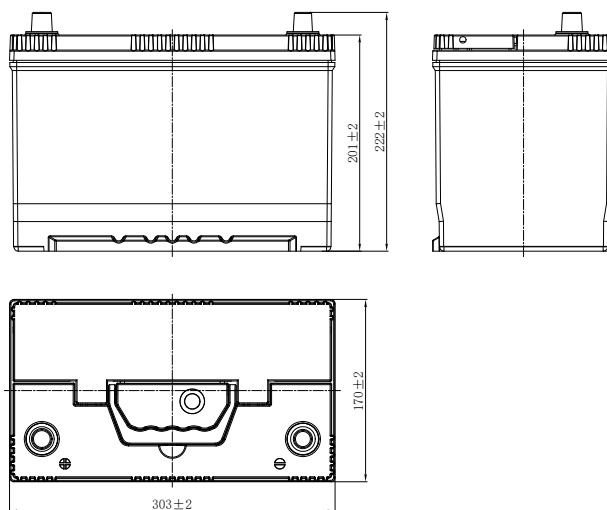
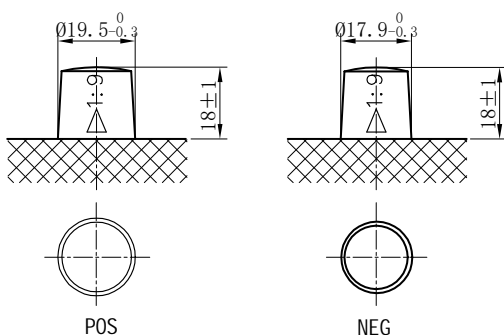

\*Values are subject to variation of +/- 5% in normal manufacturing processes.

Leoch International Technology Ltd.

[www.leoch.com](http://www.leoch.com)

Leoch Batteries Pte Ltd

[www.leoch.sg](http://www.leoch.sg)

Leoch Battery Corporation

[www.leochamericas.com](http://www.leochamericas.com)

Leoch Europe S.A.

[www.leoch.eu](http://www.leoch.eu)

Data above is recommended and the picture is only for battery effect display, Leoch reserve the final right of explanation.  
© LEOCH. All rights reserved. Trademarks and logos are the property of LEOCH and its affiliates unless otherwise noted. Subject to revisions without prior notice. E&OE.

Publication No.: LB-70D31RHT-PD-EN-V1.0-20250220