

HEAVY DUTY FLOODED BATTERY

155H52R (12V165Ah)



CHARACTERISTICS

Item	Specifications	
Nominal Voltage	12V	
Nominal Capacity (20HR)	165Ah	
Reserve Capacity	324min	
Cold Cranking Amps@0°F (-18°C)	920A	
Dimension	Length	521mm(20.5inches)
	Width	261mm(10.3inches)
	Height	240.5mm(9.47inches)
Approx Weight	49.5kg(109.1lbs)	
Terminal	1	
Cell layout	3	
Hold-Down	B0	
Case	Black-PP Material	
Cover	Black-PP Material	
Handle	TS8	

APPLICATIONS

- Commercial vehicle start
- Engine start

GENERAL FEATURES

- High capacity and high CCA
- Maintenance-free
- High vibration resistance
- Strong lead-calcium alloy grids for great corrosion resistance
- High strength PP case and cover no need be worried about breakage
- OE quality certification

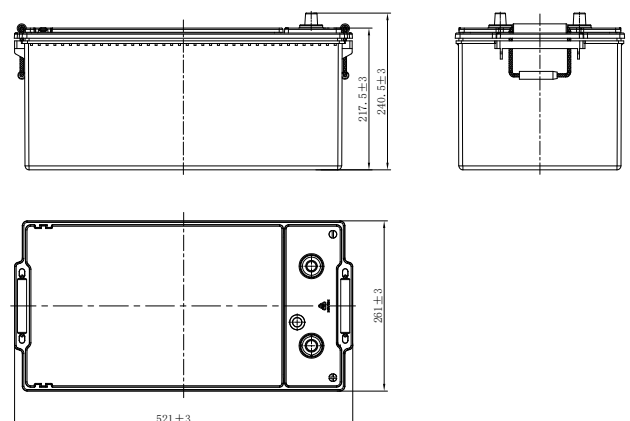
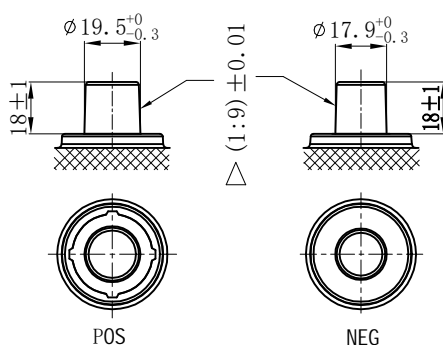

*Values are subject to variation of +/- 5% in normal manufacturing processes.

Leoch International Technology Ltd.
www.leoch.com

Leoch Batteries Pte Ltd
www.leoch.sg

Leoch Battery Corporation
www.leochamericas.com

Leoch Europe S.A.
www.leoch.eu

Data above is recommended and the picture is only for battery effect display, Leoch reserve the final right of explanation.
© LEOCH. All rights reserved. Trademarks and logos are the property of LEOCH and its affiliates unless otherwise noted. Subject to revisions without prior notice. E&OE.

Publication No.: LB-155H52R-PD-EN-V1.0-20250220