

# FLOODED BATTERY

55D26R (12V60Ah)



## CHARACTERISTICS

Item	Specifications	
Nominal Voltage	12V	
Nominal Capacity (20HR)	60Ah	
Reserve Capacity	98min	
Cold Cranking Amps@0°F (-18°C)	500A	
Dimension	Length	259mm(10.2inches)
	Width	174.8mm(6.88inches)
	Height	221mm(8.70inches)
Approx Weight	16.5kg(36.4lbs)	
Terminal	1	
Cell layout	1	
Hold-Down	B1	
Case	Black-PP Material	
Cover	Black-PP Material	
Handle	TS1	

## APPLICATIONS

- Car start
- EV/HEV
- Engine start

## GENERAL FEATURES

- High capacity and high CCA
- Long life
- Advanced lead-calcium alloy technology, maintenance-free design
- Patented venting system bring less water loss and prevent acid leakage
- OE quality certification

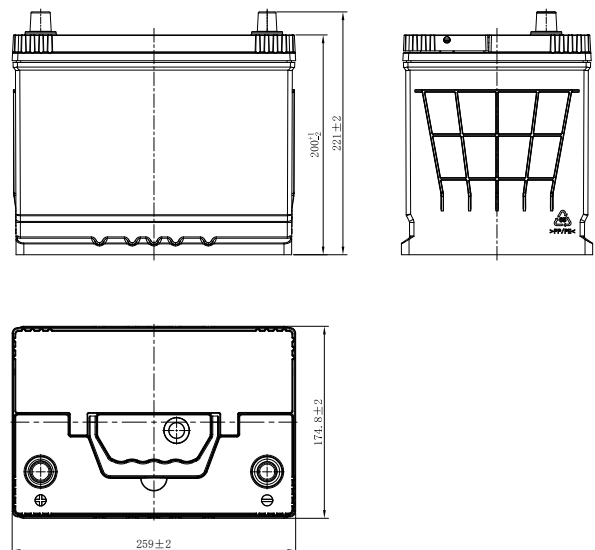
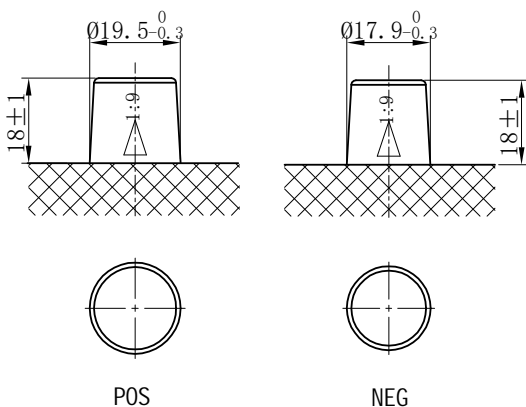

\*Values are subject to variation of +/- 5% in normal manufacturing processes.

Leoch International Technology Ltd.  
www.leoch.com

Leoch Batteries Pte Ltd  
www.leoch.sg

Leoch Battery Corporation  
www.leochamericas.com

Leoch Europe S.A.  
www.leoch.eu

Data above is recommended and the picture is only for battery effect display, Leoch reserve the final right of explanation.  
© LEOCH. All rights reserved. Trademarks and logos are the property of LEOCH and its affiliates unless otherwise noted. Subject to revisions without prior notice. E&OE.

Publication No.: LB-55D26R-PD-EN-V1.0-20250220