

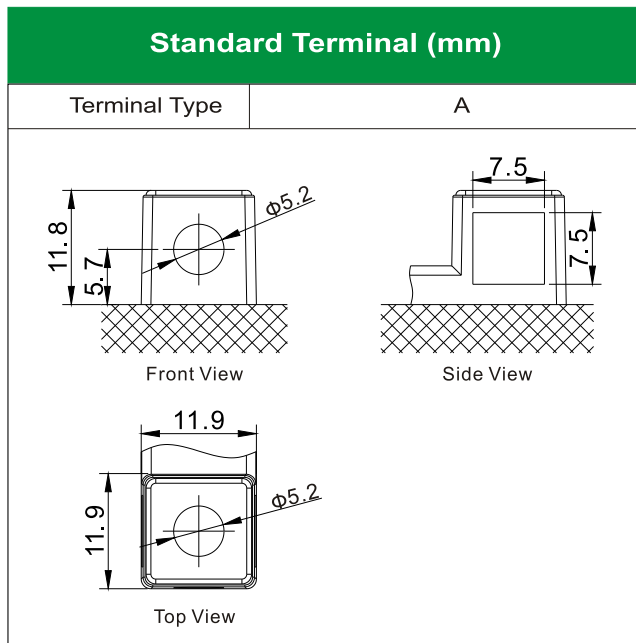

LEOCH BATTERY EBX5L-BS (12V4Ah)

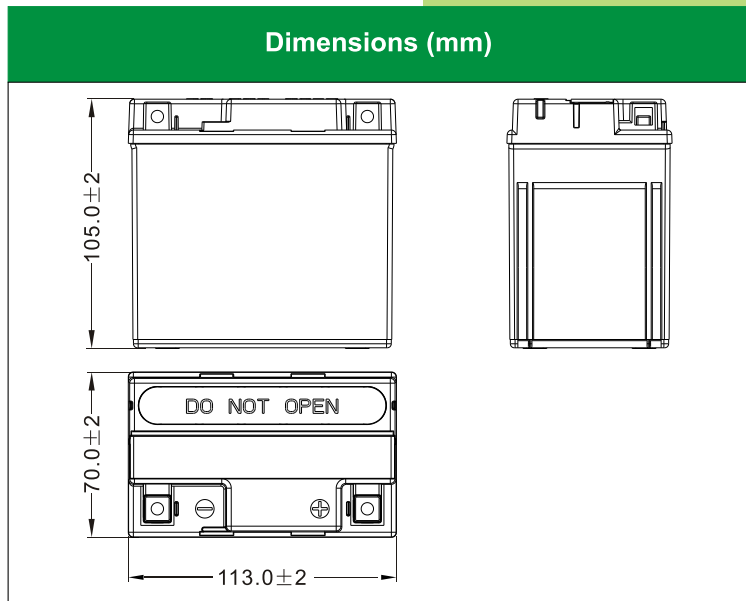

Physical Specification

Nominal Voltage	12V	
Nominal Capacity (10HR)	4Ah	
Dimension	Length	113 ± 2mm (4.45 inches)
	Width	70 ± 2mm (2.76 inches)
	Container Height	105 ± 2mm (4.13 inches)
	Total Height (with Terminal)	105 ± 2mm (4.13 inches)
Weight	Battery(with acid): Approx 1.83kg (4.04lbs) Electrolyte: Approx 0.31kg (0.68lbs)	

- * Sealed AGM battery
- * Fresh Pack, Maintenance Free
- * Powerful 70 cold cranking amps
- * Rest after filling acid
- * Maximum tilt angle for installation: 25°

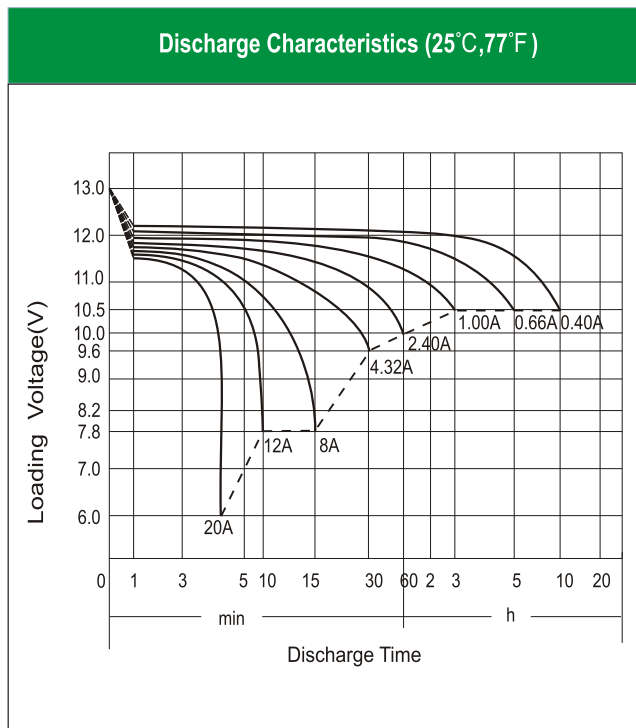

Electrical Specification

Rated Capacity	10 hour rate (0.40 A)	4.00Ah
	5 hour rate (0.66 A)	3.28Ah
	2 hour rate (1.40 A)	2.80Ah
	1 hour rate (2.40 A)	2.40Ah
	0.5 hour rate (4.32 A)	2.16Ah
Capacity affected by Temperature	40 °C (104 °F)	106%
	25 °C (77 °F)	100%
	0 °C (32 °F)	86%
	-15 °C (5 °F)	65%
Charging Methods	Full Charge	Constant-Voltage Charge: Initial charging current: less than 1.2A Voltage: 14.40 V ~ 15.00 V at 25 °C (77 °F) Charging time: 15 ~18h Constant-Current Charge: Charging current: 0.1C ₁₀ =0.40A, when charging voltage up to 14.40V, continue to charge 4h
	Floating Charge	No limit on Initial charging current Voltage: 13.50 V ~ 13.80 V at 25 °C (77 °F)