

FLOODED HIGH TEMPERATURE BATTERY

68028HT (12V180Ah)



CHARACTERISTICS

Item	Specifications	
Nominal Voltage	12V	
Nominal Capacity (20HR)	180Ah	
Reserve Capacity	360min	
Cold Cranking Amps@0°F (-18°C)	1000A	
Dimension	Length	518mm (20.4inches)
	Width	274mm (10.8inches)
	Container Height	216mm (8.50inches)
	Total Height (with Terminal)	236.5mm (9.31inches)
Approx Weight	52.7kg (116.2lbs)	
Terminal	1	
Cell layout	3	
Hold-Down	B0	
Case	Black-PP Material	
Cover	Black-PP Material	
Handle	TS8	

APPLICATIONS

- Car start
- EV/HEV
- Engine start

GENERAL FEATURES

- Design for high temperature countries and regions
- Superior life in high temperature environment
- High tin alloy and thicker positive grid
- High-temp paste
- Patented venting system bring less water loss and prevent acid leakage

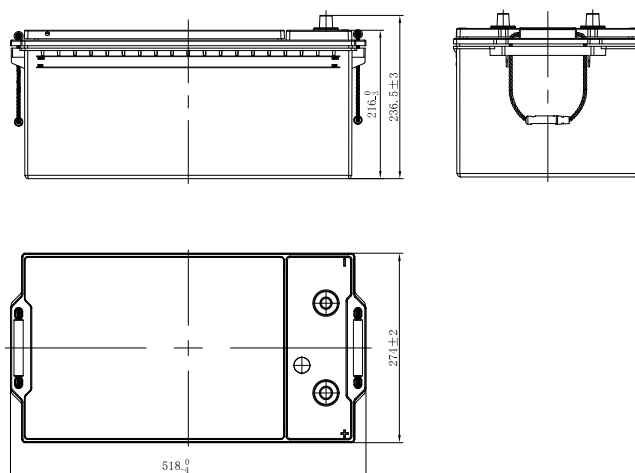
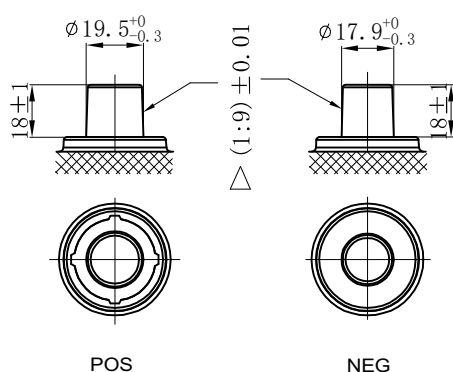

*Values are subject to variation of +/- 5% in normal manufacturing processes.

Leoch International Technology Ltd.
www.leoch.com

Leoch Batteries Pte Ltd
www.leoch.sg

Leoch Battery Corporation
www.leochamericas.com

Leoch Europe S.A.
www.leoch.eu