

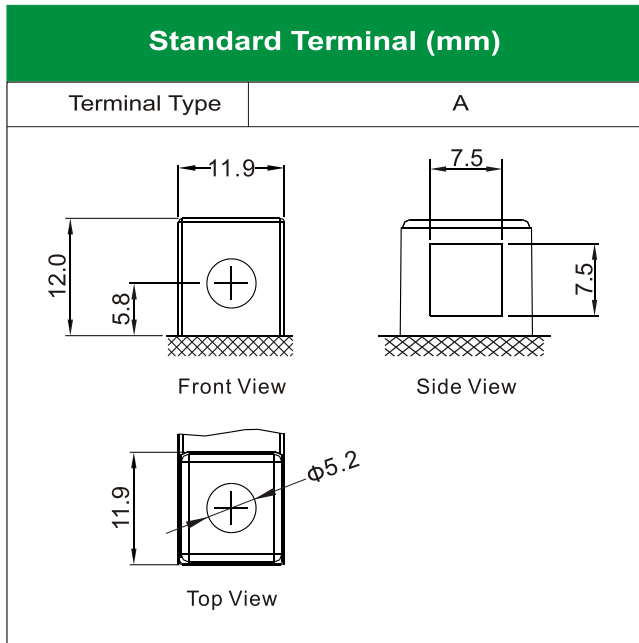

LEOCH BATTERY EB5.5-3 (12V5.5Ah)

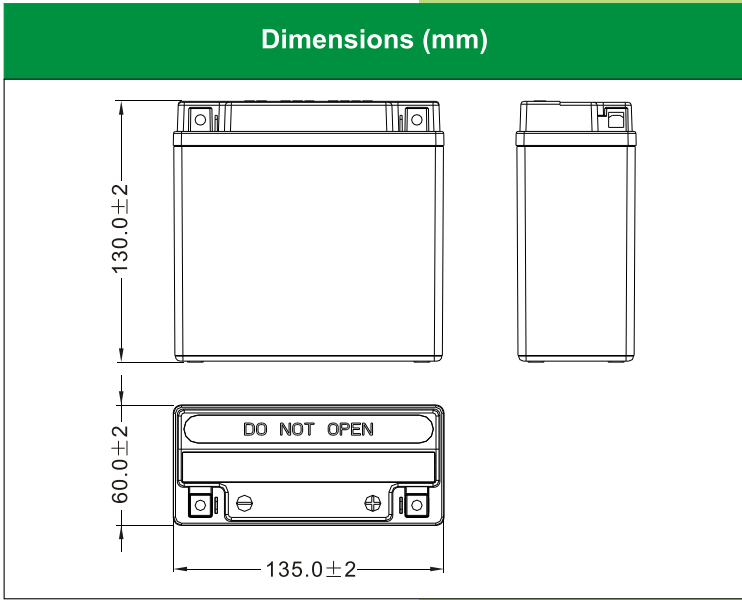

Physical Specification

Nominal Voltage	12V	
Nominal Capacity (10HR)	5.5Ah	
Dimension	Length	135±2mm (5.31 inches)
	Width	60±2mm (2.36 inches)
	Container Height	130±2mm (5.12 inches)
	Total Height (with Terminal)	130±2mm (5.12 inches)
Weight	Battery(with acid): Approx 2.10kg (4.63lbs)	
	Electrolyte: Approx 0.47kg (1.03lbs)	

- * Sealed and non-spillable AGM battery
- * Maintenance-free
- * Powerful 75 cold cranking amps
- * Shipped pre-charged and ready to install
- * Replaces EBX5.5L-BS battery

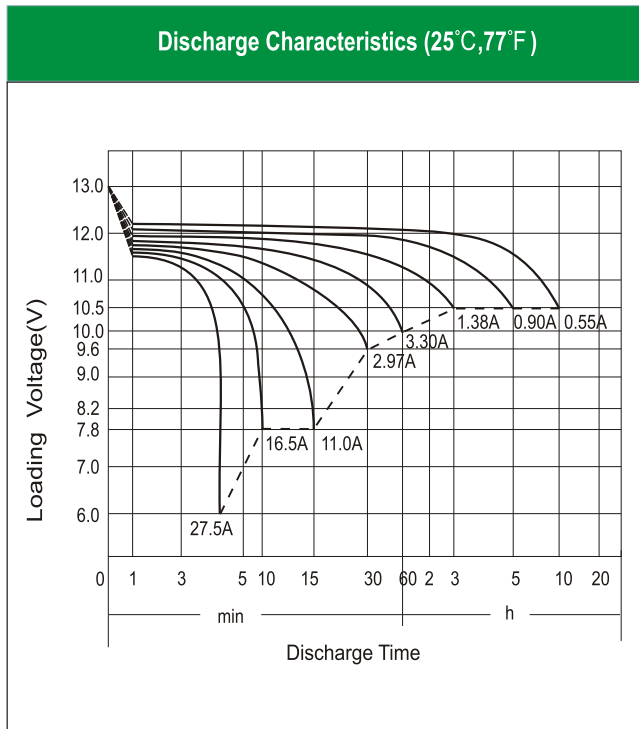

Electrical Specification

Rated Capacity	10 hour rate (0.55 A)	5.50Ah
	5 hour rate (0.90 A)	4.51Ah
	2 hour rate (1.93 A)	3.85Ah
	1 hour rate (3.30 A)	3.30Ah
	0.5 hour rate (2.97 A)	2.97Ah
Capacity affected by Temperature	40 °C (104 °F)	106%
	25 °C (77 °F)	100%
	0 °C (32 °F)	86%
	-15 °C (5 °F)	65%
Charging Methods	Full Charge	Constant-Voltage Charge: Initial charging current: less than 1.65A Voltage: 14.40 V ~ 15.00 V at 25 °C (77 °F) Charging time: 15 ~18h Constant-Current Charge: Charging current: 0.1C ₁₀ =0.55A, when charging voltage up to 14.40V, continue to charge 4h
	Floating Charge	No limit on Initial charging current Voltage: 13.50 V ~ 13.80 V at 25 °C (77 °F)